

CHECKER LID

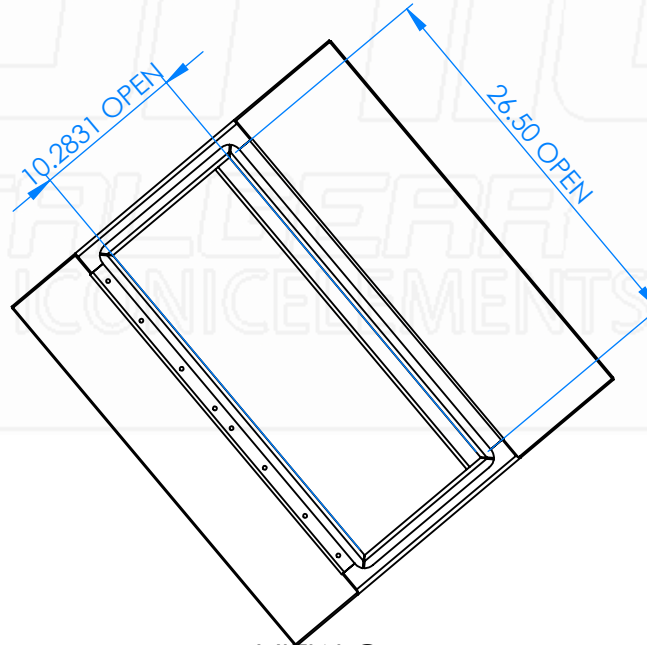
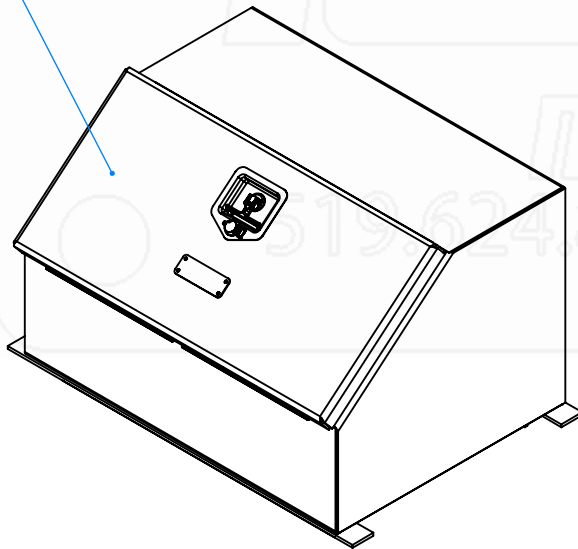

VIEW C
SCALE 1 : 13

Part No.:

1821

MATERIAL: 5052 (Alum)

THICKNESS: 0.125

FINISH: Smooth

DWG. NO.: 3508-C-00-E

Approx. Weight: 47.73 lbs

Surf. Area: 51.20 sq. ft.

ICONIC ELEMENTS (ICONIC METALGEAR) TITLE:

PROPRIETARY AND CONFIDENTIAL
NO PART OF THIS DOCUMENT MAY BE REPRODUCED, STORED IN A RETRIEVAL SYSTEM, OR TRANSMITTED IN ANY FORM, WITHOUT THE WRITTEN PERMISSION OF Iconic Elements Inc. (ICONIC METALGEAR)

30" Boot Box (CH Lid)

REV: SHEET:

E 1 OF 1